

GRP-End Cover

pressed

ULKE 53.600

EAN Code: 4013339965793

Smallest packaging unit: 1 pc.

the photorealistic images are to be considered as reference images

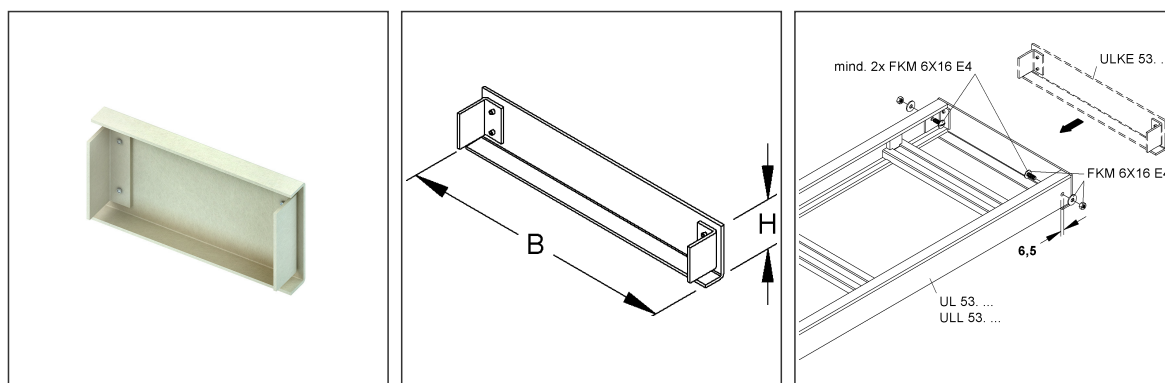
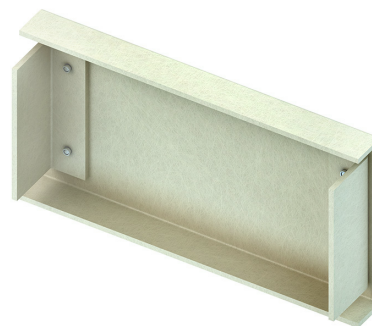

Article Description

GRP-end cover for UL, 53x600 mm, glass fiber reinforced polyester, pressed, RAL 7032, pebble grey

Excl. Accessories

exclusive bolting Required fixing accessories min. 2 pieces FKM 6X16 E4 (please order separately).

Additional Price Information

Article group	N15
quantity unit	pcs.

Weight

Weight per quantity unit	182 g / pcs.
Weight in kg per 100	18 kg / 100pcs.

Technical Datasheet

Cable Ladder System

ULKE 53.600

the photorealistic images are to be considered as reference images

Physical Article Dimensions

Height	56.00 mm
Width	598 mm
Depth/length	35.00 mm

Packing Dimension

1 piece = 1 piece		✓ VP1-smallest packaging unit (PU)			
Lenght	35.00 mm	Width	598 mm	Height	56.00 mm
Gross weight	0,18 kg	Volume	0,001 m ³		
Min. quantity	1.00 pcs.	Max. Quantity	1.00 pcs.		

Tender Text

GRP end cover, pressed, for covering the GRP cable ladder ends, proportional fastening accessories at least 2 FKM 6X16 E4 to be ordered separately, halogen-free.

for GRP cable ladder : UL 53...

ULL 53...

Dimensions (approx. dimensions) H x W : 53 x 600 mm

Material : UP-GF (glass fibre reinforced polyester)

Colour : pebble grey RAL : 7032 (similar)

NIEDAX Model-No. : ULKE 53.600

EP Material_____ EP Wage_____

Unit price/piece

Safety & Environment

REACH Date	27.06.2024
REACH Info	Conformable
RoHS Info	Conformable

Origin & International Trade

Country of origin	FR
Customs tariff number	39259020